



TECHNICAL DATA SHEET

EIA Connectors

Kabelwerk | **EUPEN** AG

Rev.: 06/2016-12-20

cable

EIA Connectors EIA78V...N, EIA158V...N

FEATURES

- **Low reflection coefficient**
- **High contact force through inner contacts made in a high-strength copper alloy**
- **Watertight (IP67/IP68)**
- **Corrosion resistant**
- **O-ring sealing**



Connectors with EIA 7/8" or EIA 1-5/8" flanges for 1/2", 7/8", 1-1/4" and 1-5/8" cables. The connectors are easy to install. Contact surfaces are silver plated to obtain a low contact resistance and very low intermodulation. Watertightness is achieved by using high-quality o-rings. The straight coupling adapter (with O-ring and bolts), for mating two EIA interfaces together, is sold separately.

SPECIFICATIONS

Cable type	1/2"	7/8"	1-1/4"	1-5/8"	
Flange type	EIA 7/8"	EIA 7/8"	EIA 7/8"	EIA 7/8"	EIA 1-5/8"
Electrical specifications					
• Nominal impedance [Ω]	50				
• Reflection coefficient @ 2.7 GHz	≤ 0.015 (≥ 36 dB)	≤ 0.020 (≥ 34 dB)	≤ 0.030 (≥ 31 dB)	≤ 0.030 (≥ 31 dB)	
• Insulation resistance [GΩ]	≥ 15			≥ 30	
• Test voltage at sea level [kV rms, 50Hz]	3.8			7.0	
• Screening effectiveness @ 1 GHz [dB]	> 128				
• PIM ratio (2 x 20 W carrier) [dBc]	≤ -155 (typical -163)				
• Maximum power rating* [kW]					
800 - 1000 MHz	1.10		1.8	5.0	
1700 - 2200 MHz	0.72		1.2	3.2	
Mechanical specifications					
• Tensile strength of coupling mechanism [N]	1000				
• Cable retention [N]	> 130	> 170	> 200	> 250	
• Mechanical endurance (Nr. of couplings)	≥ 100				
• Overall outer diameter [mm]	57	57	57	57	89
• Length [mm]	85	81	93	105	108
• Weight [g]	280	380	630	865	1250
Environmental specifications					
• Temperature range	-40 to +85 °C (-40 to +185 °F)				
• Degree of protection	IP67 / IP68 (mated connectors)				
Materials					
• External parts	Copper alloy with nickel plating				
• Outer contact	Copper alloy with passivated silver				
• Inner contact	Passivated silver plated copper alloy				
• Insulators	PTFE, PE				
• Gaskets	O-rings				
Cable dimensions					
• Compatible EUPEN cables	EC4-50	EC5-50-A	EC6-50-A	EC7-50-A	
• Inner conductor outer diameter [mm]	4.75 to 4.85	-	-	-	
• Inner conductor inner diameter [mm]	-	8.4 to 8.6	11.9 to 12.3	14.5 to 14.9	
• Outer conductor outer diameter [mm]	13.7 to 13.9	24.7 to 25.3	35.8 to 36.2	46.3 to 46.9	
• Jacket outer diameter [mm]	15.6 to 16.4	27.5 to 28.1	38.5 to 39.5	49.4 to 50.6	
Product references					
• Connector code	EIA78V12N	EIA78V78N	EIA78V114N	EIA78V158N	EIA158V158N
• Straight coupling adapter (sold separately)	EIA78CH				EIA158CH

* 40 °C ambient temperature, 80 °C inner conductor temperature



INSTALLATION INSTRUCTIONS

50 Ohm EIA CONNECTORS

Kabelwerk | **EUPEN** AG

M36387 - M36388 - M36389
Rev.00/2017-03-03

cable

1/2

EIA connectors for cables 7/8" to 1-5/8"



EIA78V78N



EIA78V114N



EIA78V158N



EIA158V158N

Coupling hardware
(sold separately):



EIA78CH
(for interface EIA 7/8")



EIA158CH
(for interface EIA 1-5/8")

7/8"	EC5-50-A (5228 A)
1-1/4"	EC6-50-A (5328 A)
1-5/8"	EC7-50-A (5438 A)



Vaseline



Mastic tape*

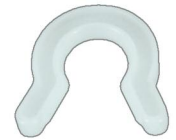

Saw-guide

* A Butyl mastic tape is available in our Weatherproofing Tape Kit (ref. 2849996)

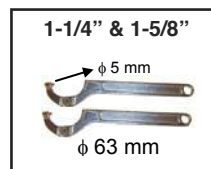
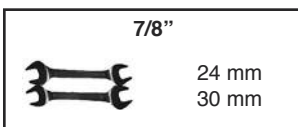

Manual method

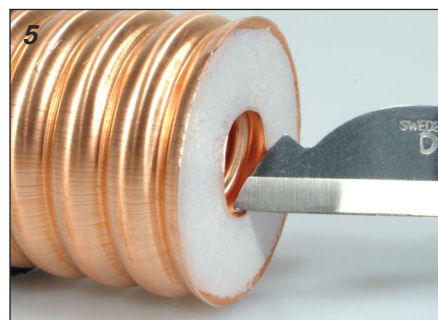
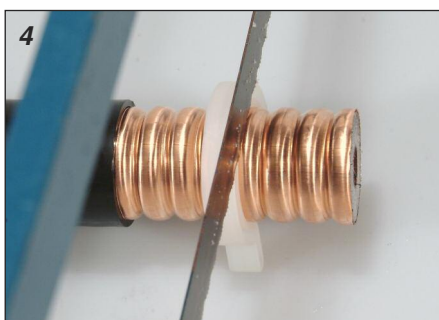
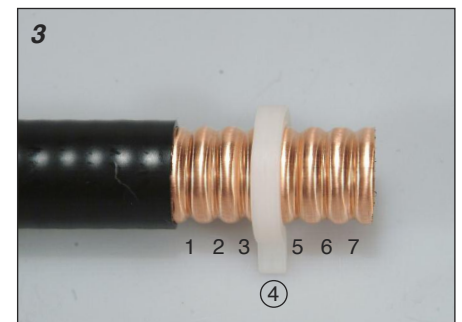
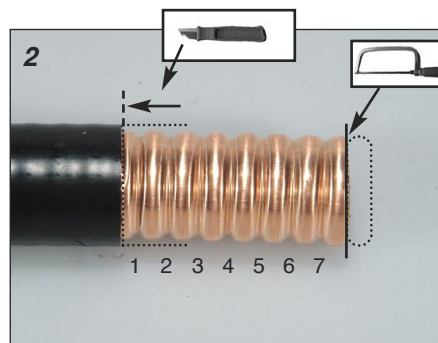
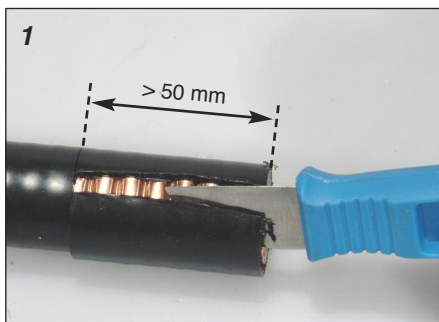



INSTALLATION INSTRUCTIONS

50 Ohm EIA CONNECTORS

Kabelwerk | **EUPEN** AG

M36387 - M36388 - M36389
Rev.00/2017-03-03

cable

2/2

EIA connectors for cables 7/8" to 1-5/8"

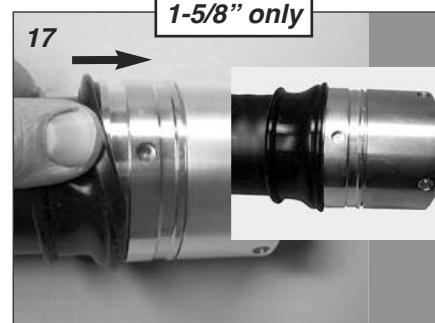
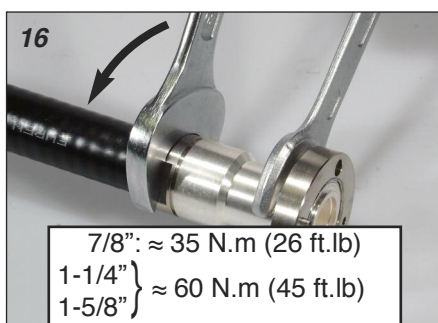
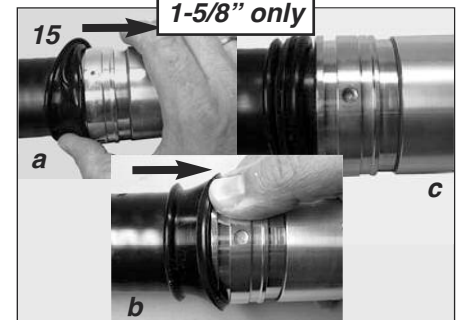
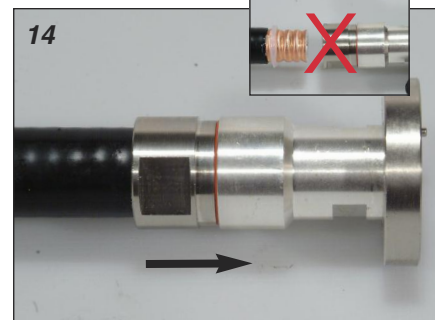
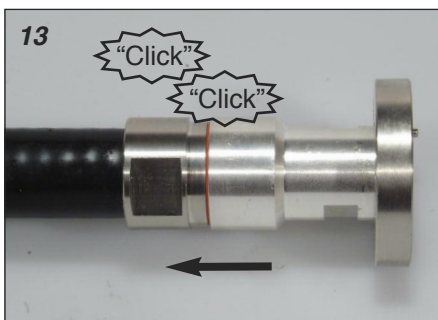
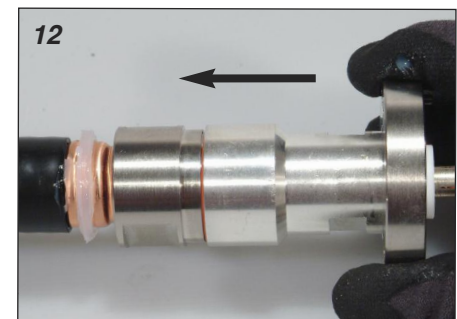
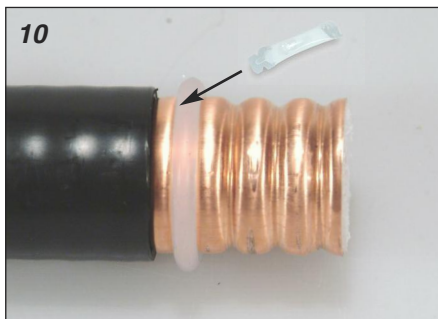
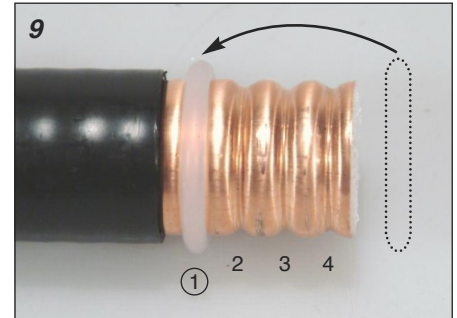
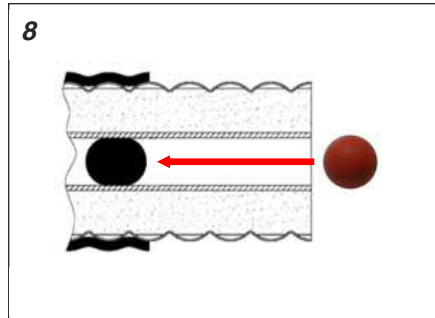
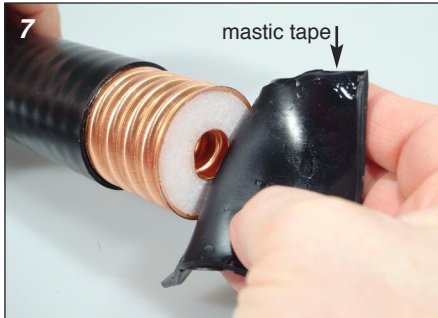

For any questions please contact KABELWERK EUPEN AG / for US Customer service call 1-800-419-5100

(D) Verarbeitung nur durch eine Elektrofachkraft.
Es besteht die Gefahr eines elektrischen Schlagess!

(F) Installation uniquement par une personne qualifiée en électricité.
Il y a un risque de choc électrique!



(NL) Installatie alleen door een vakman voor elektriciteit.
Er is gevaar van elektrische schok!

(GB) Processing only by a qualified electrician.
There is a risk of electric shock!

NOTI E:
KABELWERK EUPEN AG
disclaims any liability or
responsibility for the results
of improper or unsafe installa-
tion practices.

AVIS:
KABELWERK EUPEN AG
décline toute responsabilité
en cas de non respect de
ces instructions.

WAARS HUWING:
KABELWERK EUPEN AG
wijst elke verantwoordelijk-
heid van de hand in geval
van het niet opvolgen van
deze aanbevelingen.

BEMERKUNG:
KABELWERK EUPEN AG
lehnt jede Verantwortung bei
Nichtbeachtung dieser
Instruktionen ab.

AVISO:
KABELWERK EUPEN AG
rehusa todas las responsibi-
lidades en caso de no
respetar las instrucciones.

注意:
本公司声明对于不恰当或不
安全的安装, 检验, 维修或拆
卸操作所导致的后果不负任
何义务和责任