

RECOMMENDED
CABLE STRIPPING DIM'S
(建議剝線尺寸)

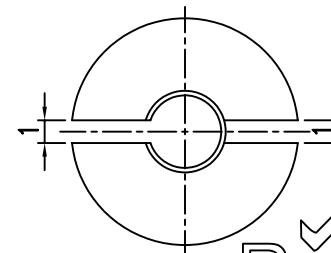
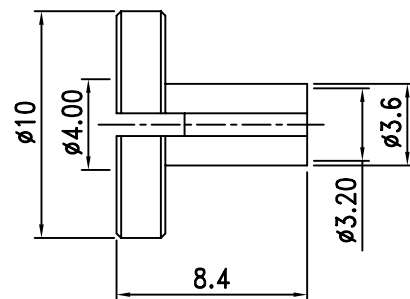
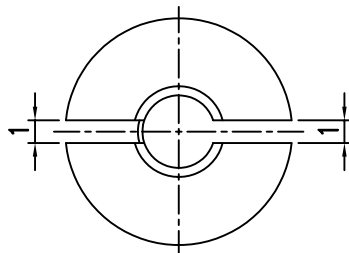
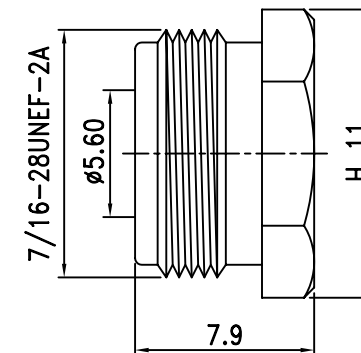
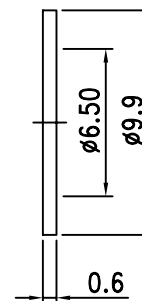
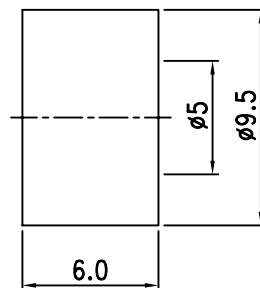
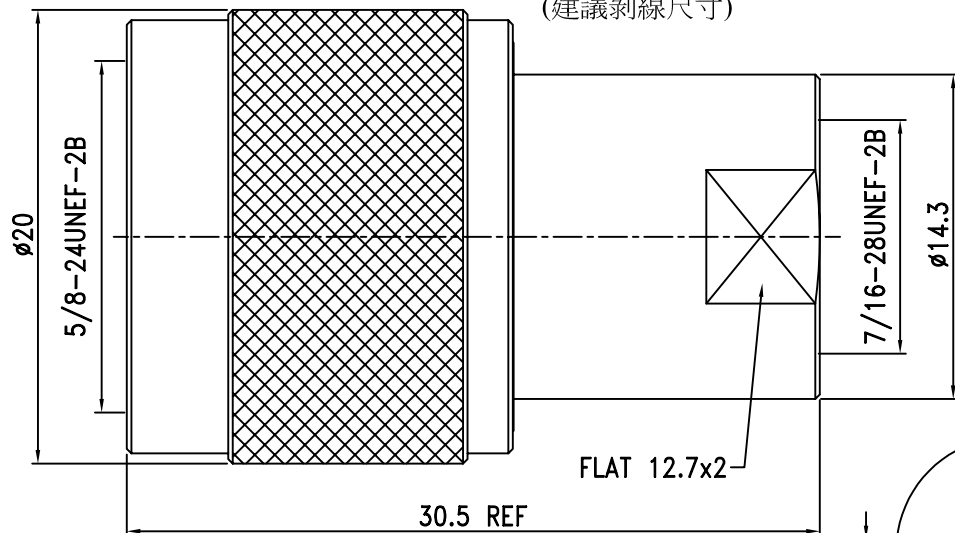
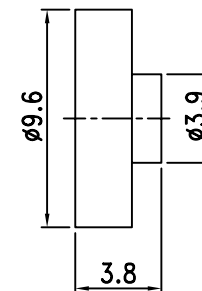
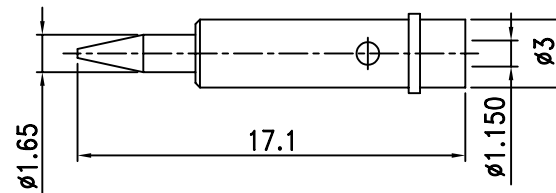
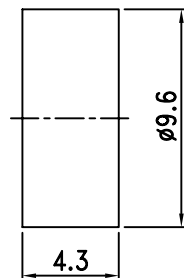

ROHS
COMPLIANT

12.	Nut	Brass	1	Silver
11.	Washer	Brass	1	Silver
10.	Gasket	Silicone	1	Black
9.	Braid Clamp	Brass	1	Silver
8.	Shell	Brass	1	Silver
7.	Gasket	Silicone	1	Red
6.	Retaining Ring	Brass	1	Nickel
5.	Chassis	Brass	1	Silver
4.	Insulation	Teflon	1	None
3.	Insulation	Teflon	1	None
2.	Pin	Brass	1	Gold
1.	Body	Brass	1	Silver
NO.	DESCRIPTION	MATERIAL	Q' TY	FINISH

繪圖DRAWN	SCALE	UNITS	
Jenny	比例 3:1	單位 mm	
審核CHECKED	公差TOLERANCE		圖名
Peter	.X	±0.2	TITLE
主管APPROVAL	.XX	±0.1	版次REV.
	.XXX	±0.05	
Peter	ANGLE	±0.5°	A

夏尼有限公司
SHINING PRECISION CO., LTD

NEW UG 536 STG

電腦圖檔CAD FILE

日期DATE

C:/SHINING/N-PARTS/N-03F-2.DWG

2010.10.05