

REVISION

| REV. | DESCRIPTON      | DATE       | APPROVED |
|------|-----------------|------------|----------|
| T    | INITIAL RELEASE | 2012/05/14 |          |

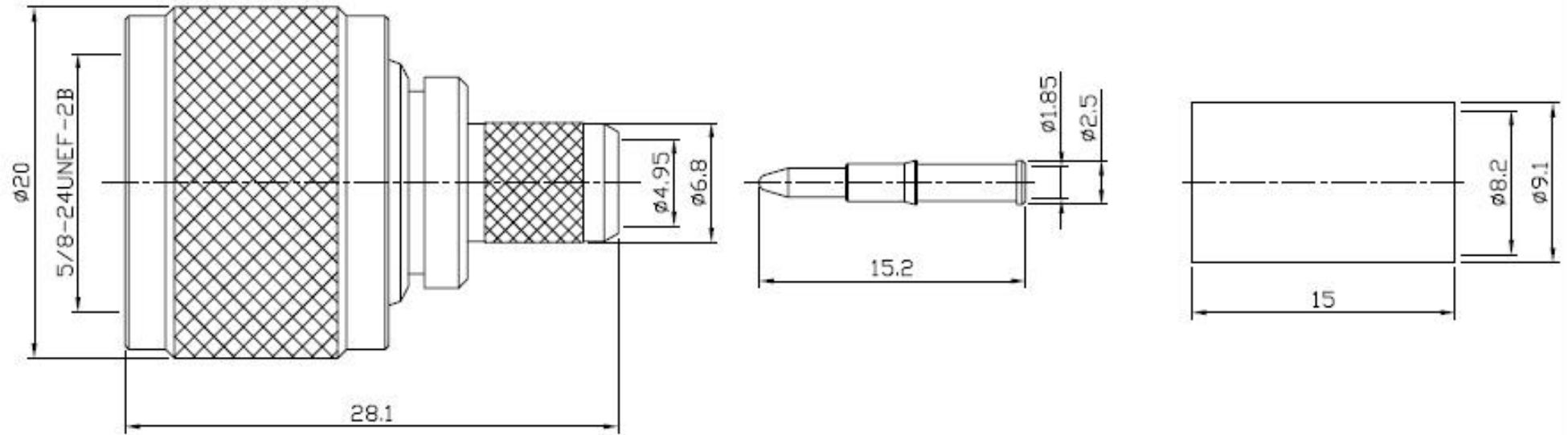

NOTES: FINISH (PLATING THICKNESS IN MICRO-INCHES)



1. BRASS.
2. TIN-ZINC-COPPER-ALLOY PL. 100 MIN.  
OVER COPPER PL. 50 MIN.
3. GOLD PL. 4 MIN. OVER NICKEL-PHOSPHORUS ALLOY  
PL. 80 MIN. OVER COPPER PL. 20 MIN.

※注意滾包零件1時不可太緊或往後掉出,要能順暢旋轉即可!!

| NO. | DESCRIPTION | MATERIAL | FINISH | QTY | PART NO.         | DIMENSION ARE MILLIMETERS<br>UNLESS OTHERWISE SPECIFIED<br>TOLERANCES                 | SCALE<br>3/1 | REV<br>T | UNIT<br>MM | JYE BAO CO., LTD.          |  |  |
|-----|-------------|----------|--------|-----|------------------|---|--------------|----------|------------|----------------------------|--|--|
| 6   | FERRULE     | COPPER   | NOTE 2 | 1   | N3100-5DFB-8/W   | 0 ~ 5 = ±0.05<br>5 ~ 10 = ±0.07<br>10 ~ 20 = ±0.10<br>20 ~ 30 = ±0.15<br>30 ~ = ±0.20 | APPROVED     |          | DATE       | TAIPEI TAIWAN              |  |  |
| 5   | GASKET      | SILICONE |        | 1   | N3100-9058-6     |   | CHECKED      |          | DATE       | TITLE<br>N PLUG CRIMP      |  |  |
| 4   | CONTACT PIN | NOTE 1   | NOTE 3 | 1   | N3100B-L300-4/NM |   | DRAWING      |          | DATE       | DRAWING NO.<br>N3100B-L300 |  |  |
| 3   | INSULATOR   | TEFLON   |        | 1   | N3100B-L200-3    |   |              |          |            |                            |  |  |
| 2   | BODY        | NOTE 1   | NOTE 2 | 1   | N3100B-L300-2/W  |   |              |          |            |                            |  |  |
| 1   | SHELL       | NOTE 1   | NOTE 2 | 1   | N3100B-1/W       |   |              |          |            |                            |  |  |

# JYE BAO CO., LTD.

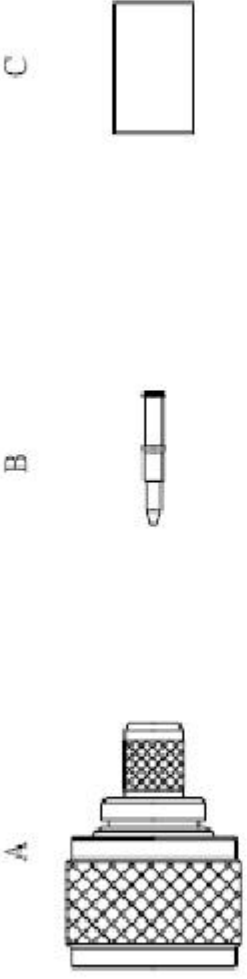
TAIPEI TAIWAN

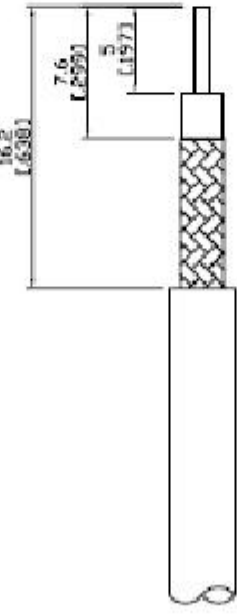
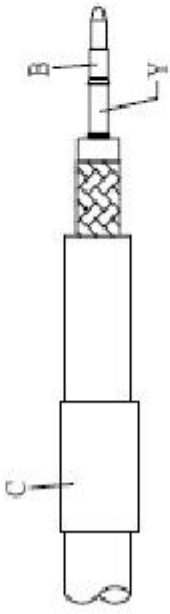
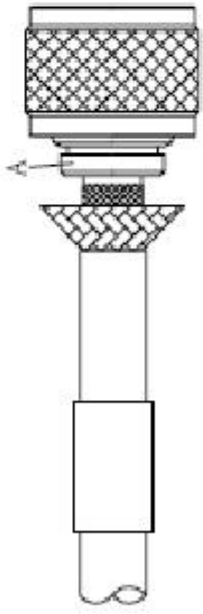
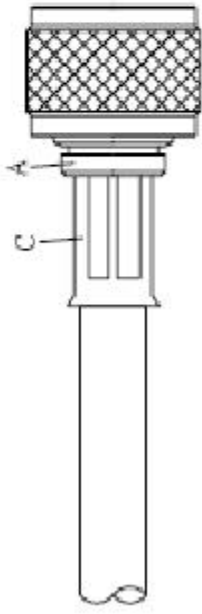
| N3100B-L300   | DATE  | 2013/11/11  | REV | — |
|---|---|---|-----|---|
| <p>A</p>  <p>BODY</p> | <p>B</p>  <p>CONTACT PIN</p>   | <p>C</p>  <p>FERRULE</p> |     |   |
| DIAGRAM   | ASSEMBLY INSTRUCTION  |   |     |   |
|                      | <p>Step 1: STRIP AS SHOWN.</p>  |   |     |   |
|                     | <p>Step 2: SLIDE FERRULE " C " OVER CABLE.<br/>           Step 3: PUT PIN " B " ON CENTER CONDUCTOR AND CRIMP IN " Y " WITH 1.6(0.063) SQUARE INSERT.</p> |   |     |   |
|                     | <p>Step 4: LOOSEN BRAIDING AND SLIDE CONNECTOR " A " IN PLACE.</p>  |   |     |   |
|                     | <p>Step 5: SLIDE FERRULE " C " TOWARDS THE CONNECTOR " A " AND CRIMP WITH 7.9(0.311) HEX INSERT.</p>  |   |     |   |